

CORNER DETAIL

N.T.S.

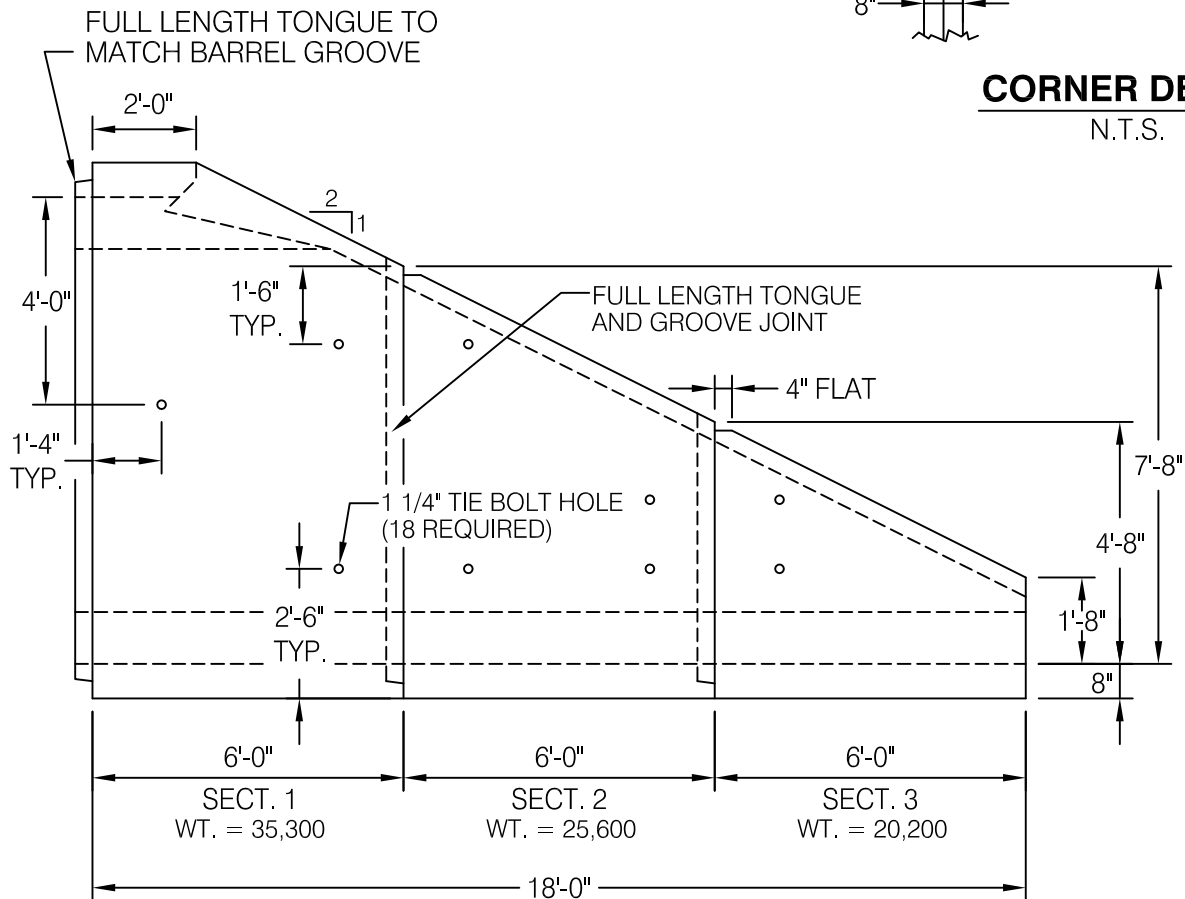

SIDE VIEW

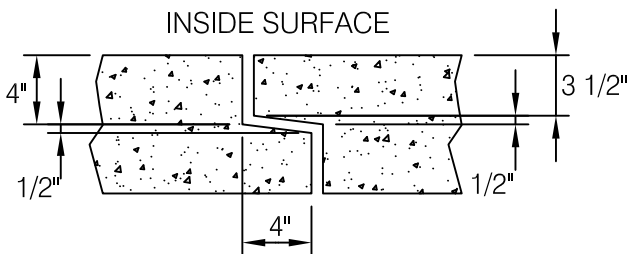

TYPICAL JOINT DETAIL



10' x 9' Double Cell Sloped End

SCALE 1/4"=1'-0" DATE 6/14/16 DWG. NO.